

GMX300 Compact Weather Station

The MaxiMet range of compact weather stations is designed and manufactured by Gill Instruments. MaxiMet products use reliable, high quality instruments to provide accurate meteorological information in a wide variety of applications.

GMX300 Features

Temperature, humidity, pressure. A combined instrument mounted inside three double louvered, naturally aspirated radiation shields with no moving parts. The results are high performance across each measurement over long periods of time.

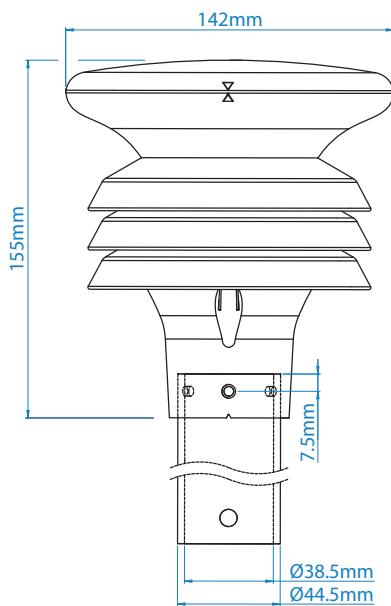

TEMP, HUMIDITY & PRESSURE	PARAMETERS
<ul style="list-style-type: none"> Air Pressure / Temperature Relative / Absolute humidity Naturally aspirated UV stable radiation shield Protection against wind-blown precipitation/dust 	<ul style="list-style-type: none"> Temperature °C / °F / °K Relative humidity % Rh, g/m³, g/kg Barometric pressure hPa, bar, mm Hg Wet bulb temperature °C / °F / °K Absolute humidity g/m³ Air density kg/m³ Outputs RS232, 422, 485 (ASCII), SDI-12, NMEA, MODBUS, Analogue (option)

All MaxiMet Models Feature

- Quality Measurements
- Lightweight and Robust
- Low Power Mode
- Free of Charge Software
- Gill Proven Reliability
- Compact Integrated Design
- Real Time Output
- Easy Installation
- Gill Customer Support
- 2 Year Warranty

Applications

- Building and Industrial Controls
- Authorities
- Transport
- Coastal
- Agricultural
- Safety
- Educational
- Commercial
- Energy

TEMPERATURE	
Range	-40°C to +70°C
Resolution	0.1
Accuracy	± 0.3°C @ 20°C
Sampling Rate	1 Hz
Units	°C, °F, °K

PRESSURE	
Range	300 to 1100
Resolution	0.1 hPa
Accuracy	± 0.5 hPa @ 25°C
Sampling Rate	1 Hz
Units	hPa, bar, mmHg, inHg

POWER	
Power Supply	5 to 30 Vdc
Power (Nominal) 12 Vdc	10 mA continuous high mode. 0.7 mA eco-power mode (1 hour polled)

HUMIDITY	
Range	0-100%
Resolution	1%
Accuracy	± 2% @ 20°C (10%-90% RH)
Sampling Rate	1 Hz
Units	% Rh, g/m3, g/Kg

OUTPUTS	
Output rate	1/s, 1/min, 1/hr
Digital Comms Modes	Serial RS232, RS422, RS485, SDI-12, NMEA, MODBUS, ASCII
Analogue Outputs	Available via separate optional device

ENVIRONMENTAL CONDITIONS	
IP Rating	66
Operational Temperature Range:	-40°C to +70°C
EMC Standard:	BS EN 61326 : 2013 FCC CFR47 parts 15.109
CE Marking	YES
RoHS compliant	YES
Weight	0.5 Kg
Origin	UK

DEW POINT	
Range	-40°C to +70°C
Resolution	0.1
Accuracy	± 0.3°C @ 20°C
Units	°C, °F, °K
Sampling Rate	1 Hz

Specifications may be subject to change without prior notice

GILL

Gill Instruments Limited

Saltmarsh Park, 67 Gosport Street
Lymington, Hampshire SO41 9EG
United Kingdom

Tel: +44 (0) 1590 613 500
Fax: +44 (0) 1590 613 501
contact@gillinstruments.com



gillinstruments.com

1957-005 Iss 2

Copyright © Gill Instruments 2015

Gill Instruments Limited, Reg No. 2281574
Registered Office: The George Business Centre, Christchurch Road, New Milton, BH25 6QJ